

NO.	COMPONENTS	IMPEDANCE
1	SMA REVERSE POLARITY MALE	50 OHM
2	RG58	50 OHM
3	HEAT SHRINKING TUBE	
4	TNC REVERSE POLARITY FEMALE	50 OHM

SMA R/P MALE

TNC R/P FEMALE

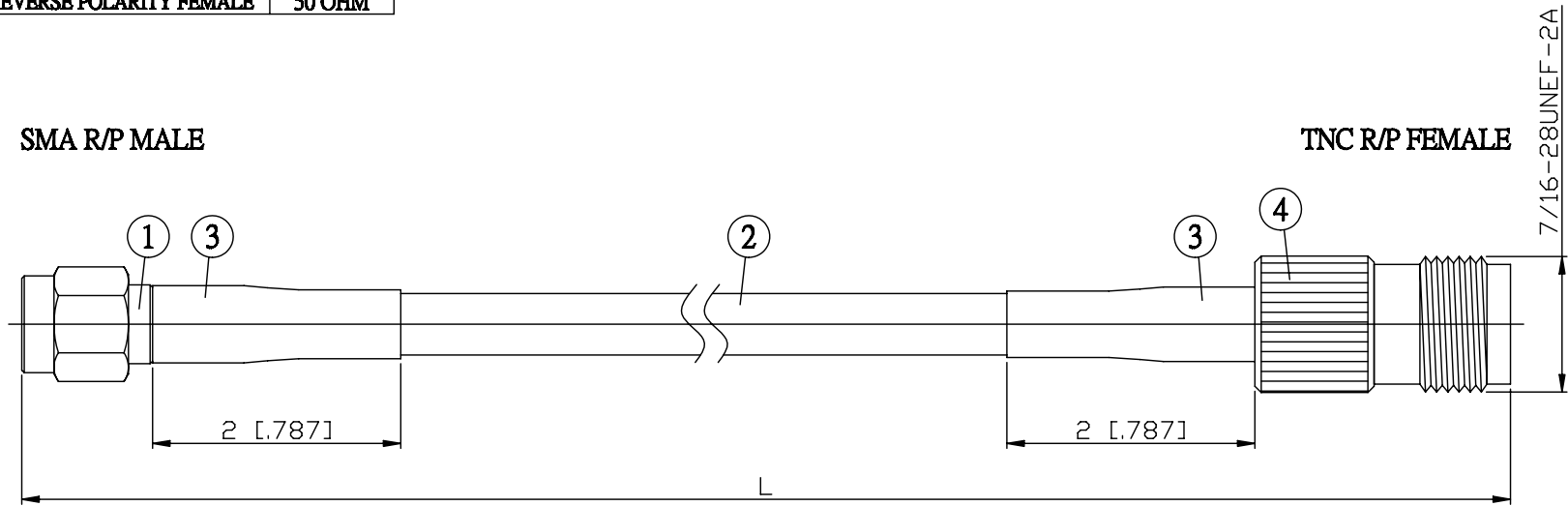

JYE BAO P/N	L CM (INCH)
A60T90-58-15	15 (5.906)
A60T90-58-30	30 (11.811)
A60T90-58-50	50 (19.685)
A60T90-58-100	100 (39.370)
A60T90-58-150	150 (59.055)
A60T90-58-200	200 (78.740)
A60T90-58-XXX	CUSTOM LENGTH IN CM

<p>LENGTH TOLERANCE IS ±1.5% OR ±10MM, WHICHEVER IS GREATER.</p>	<p>JYE BAO CO., LTD. TAIPEI TAIWAN</p>
	<p>DESCRIPTION CABLE ASSEMBLY SMA R/P PLUG TO TNC R/P JACK</p>
	<p>JYE BAO DRAWING NO. A60T90-58-XXX</p>