

NO.	COMPONENTS	IMPEDANCE
1	TNC REVERSE POLARITY MALE	50 OHM
2	RG58	50 OHM
3	HEAT SHRINKING TUBE	
4	TNC REVERSE POLARITY FEMALE FOR BULKHEAD	50 OHM

TNC R/P MALE

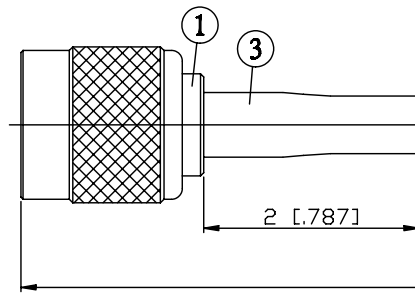

2

L

TNC R/P FEMALE FOR BULKHEAD

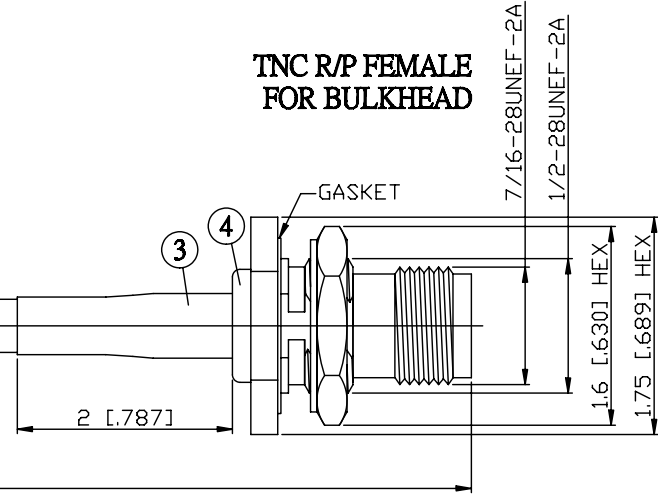

JYE BAO P/N	L CM (INCH)
T60T95-58-15	15 (5.906)
T60T95-58-30	30 (11.811)
T60T95-58-50	50 (19.685)
T60T95-58-100	100 (39.370)
T60T95-58-150	150 (59.055)
T60T95-58-200	200 (78.740)
T60T95-58-XXX	CUSTOM LENGTH IN CM

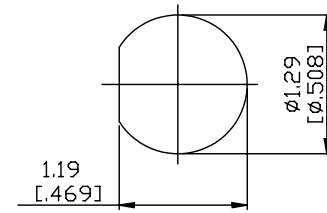

MOUNTING HOLE

<p>LENGTH TOLERANCE IS $\pm 1.5\%$ OR $\pm 10\text{MM}$, WHICHEVER IS GREATER.</p>	<p>JYE BAO CO., LTD.</p> <p>TAIPEI TAIWAN</p>
	<p>DESCRIPTION CABLE ASSEMBLY TNC R/P PLUG TO TNC R/P JACK FOR BULKHEAD</p>
	<p>JYE BAO DRAWING NO. T60T95-58-XXX</p>